



FloPro™ e3 - Variable speed

Filtration > Pumps > FloPro™ e3

3 YEAR WARRANTY

- + Guaranteed energy savings
- + Ultra-silent
- + The variable speed essentials, for all pools up to 80m³



Product offered for sale on the «pool dealer» channel

NEW FOR 2017



FloPro™ e3 100

PRODUCT REFERENCE

Standard model	WP000053
----------------	----------

ACCESSORIES INCLUDED IN THE PACK



63/50mm union tailpieces

DESCRIPTION

Operating mode(s)	1-line LCD screen (blue)
Clock / Timer	Controlled by the filtration timer
Number of speeds	3 programmable speeds (+/- 50 RPM) Factory settings: ECO (1400 RPM), CLEAN (2150 RPM) & BOOST (2850 RPM)
Priming	Automatic at startup (2 min at 2850 RPM)
Safety features	Automatic shut down in case of high or low tension
Filter basket volume	2,6 L
Compatible pipework	DN50 mm & DN63 mm (2" inlet & outlet threaded ports, 63/50mm union tailpieces provided)
Use	Fresh water and salt water up to 6 g/L (6000 ppm)

TECHNICAL CHARACTERISTICS

Motor type	Permanent magnet synchronous motor (ECM* technology), TEFC**, class F insulation
Efficiency	> 80 % (as per IE3 standard)
Output power HP (P2)	1,00 HP / 0,75 kW
Flow rate at 10 m head	16,3 m ³ /h (at 2850 RPM)
Maximum flow rate	22,4 m ³ /h
Maximum manometric Head	19,1 m
Maximum water temperature	35 °C
Speeds	1000 - 2850 RPM (adjustable by 50 RPM increments)
Protection rating	IPX5
50 Hz power supply	220-240 VAC

*: ECM = Electronically Commutated Motor (= electronically controlled permanent magnet 'brushless' motor)

** : Totally-Enclosed Fan-Cooled

ZPCE: recommended sales price valid from 01/01/2017 through 30/09/2017



PERFORMANCE

- Performance curves shown for example speeds (each speed has a unique curve).
- Manometric pressure is expressed as “pump head” in meters of water:
1 bar = 10.19 m.

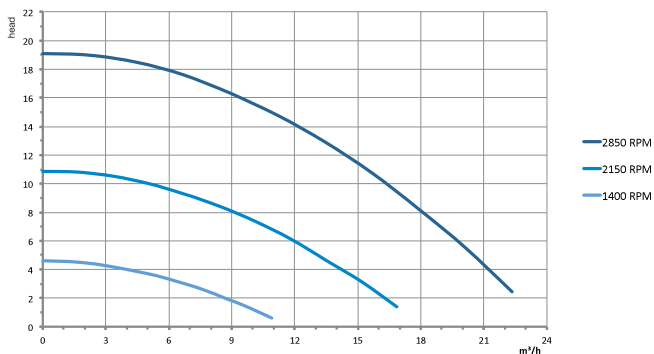

DIMENSIONS AND WEIGHT

Length	58 cm
Height	32.4 cm (without pump bases)
Width	25,4 cm
Weight (pump only)	10 kg

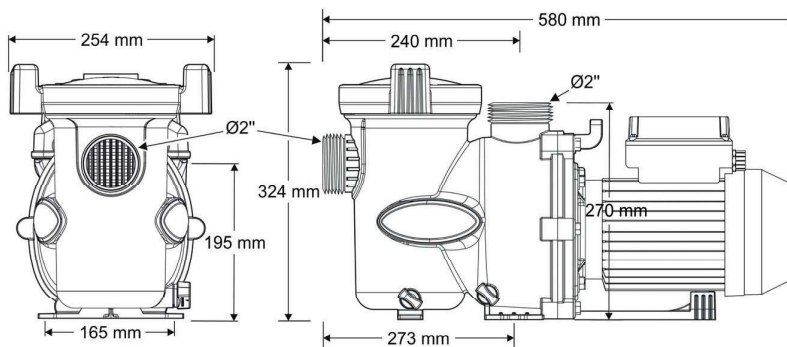

INSTALLATION

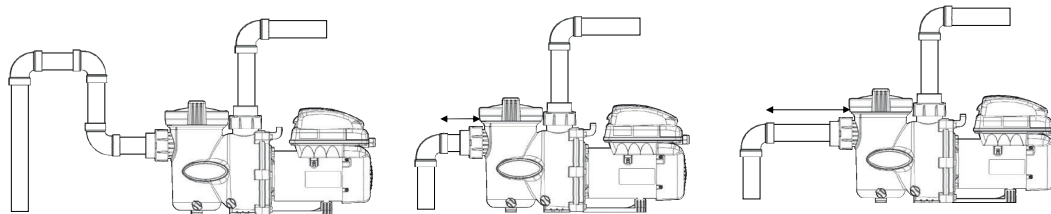

Incorrect: Air retention and risk of incorrect pre-filter filling.

Incorrect: Suction pipe too short, risk of cavitation.





Correct: Length of suction pipe = 4 x pipe diameter (20 cm for 50 mm and 25 cm for 63 mm).



Spare parts page 284

OPTIONAL ACCESSORIES

ASSOCIATED PRODUCTS

			
Small pump base R0486700	Large pump base R0546400	CS Filter WF000024/25	Filter Boreal WF000003/4/5/6/15
25,75€ ex VAT	20,60€ ex VAT		